

ieGeek

User Manual Portable Video Player

Model IK-121

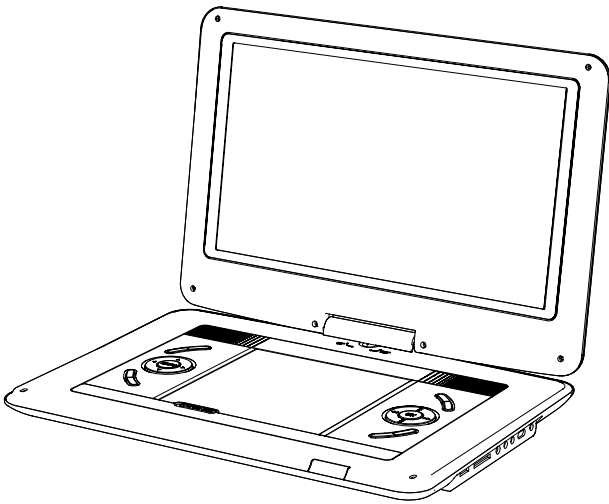

ieGeek, Makes Your Life Better.
If you have any questions, please contact:
vp-service@iegeek.com

Warm Tips

How to Get a **12-Month Warranty**

Contact us to register it within **3 weeks** after receiving your player.

Enjoy Your New DVD Player!

Email us:

vp-service@iegeek.com

CONTENT

USEFUL TIPS	1
PRODUCT DESCRIPTION	3
CONNECTION	8
SETUP PAGE.....	9
SPECIFICATIONS.....	13
TROUBLESHOOTING.....	14
WARRANTY.....	18
WARNING	19

USEFUL TIPS

1. **Battery.** Please recharge the Battery for at least 6 hours before the initial use. If you connect this player with AC power, you can use it directly.

Note: Make sure you switch off the unit before charging. The charging indicator LED will change from RED to OFF to indicate that the battery has been fully charged. When the unit is on, the LED turns GREEN.

2. **LCD Screen.** If you find scratches on the screen , just remove the screen protector.

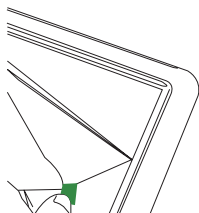

3. **Laser Pickup.** There is a yellow card inside the player. Before you insert a disc, please remove the card. Please DO NOT touch the laser pickup or other parts with your hand.

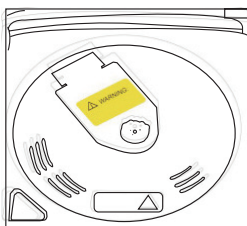

4. Disc Format

Disc Format Supported	CD, DVD, DVD + R/-R, DVD + RW/-RW, VCD, SVCD, CD-R/RW
Disc Format NOT Supported	Blu-ray, HD DVD, Discs recorded in the AVCHD format, DVD-Audio, Version 1.0 of DVD-RW, DVD-ROM, CD-ROM, CDV, CD-G, SACD, Photo CD, DVD-RAM that cannot be removed from their cartridges, 2.6-GB and 5.2-GB DVD-RAM, PAL discs.

5. **Language Settings.** Press key [SET UP] → [OSD language]→ Change the display language. It is the same procedure for Audio, Subtitles and Menu.
6. **About the Game.** If you want to play games on our device, please check the free drop box link below:
<https://soursl.cn/XVcBpM>
7. **About the Maintenance.**
 - Wipe with a soft, dry cloth to clean this unit.
 - Use eyeglass cleaner to remove stubborn dirt from the LCD.
 - Do not use alcohol, paint thinner or benzine to clean it.
 - Do not press onto the LCD screen or drop the product from a high place.
 - This unit is not waterproof. To prevent a fire, do not place any container filled with liquid near this unit (such as a vase or flower pot) or expose it to dripping, splashing, rain or moisture.

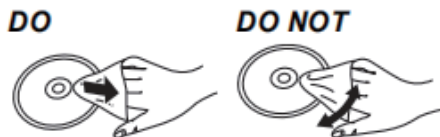

- To clean discs, wipe with a damp cloth and then wipe dry.
- Do not attach labels or stickers to any discs (This may cause disc warping, making it unusable).
- Do not write on the discs with a ball-point pen or any other writing instrument.
- To protect discs from scratches and dirt, please return them to their cases or cartridges when they are not in use.
- Do not use discs that are badly warped or cracked, or irregularly shaped discs, such as heart shapes.

PRODUCT DESCRIPTION

Package Contents

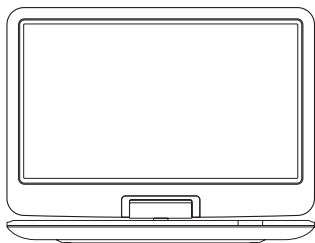

①



②

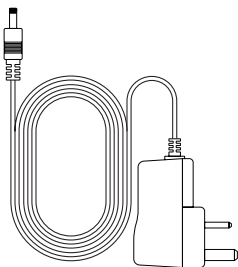

③

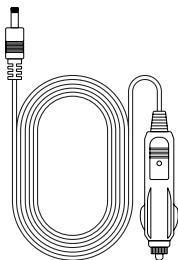

④

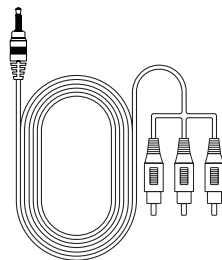

⑤

① Portable Video Player

④ Car Charger

② Remote Controller

⑤ 3-in-1 AV Cable

③ AC Adapter

Button Introduction

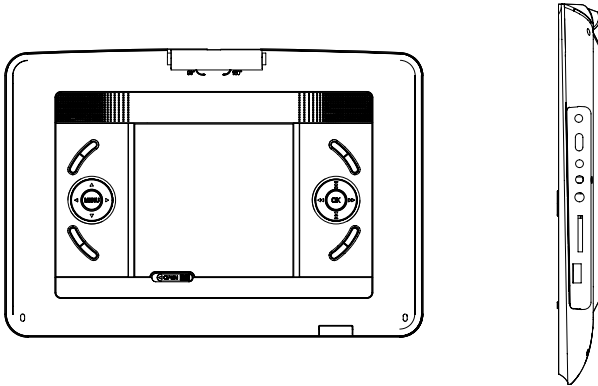





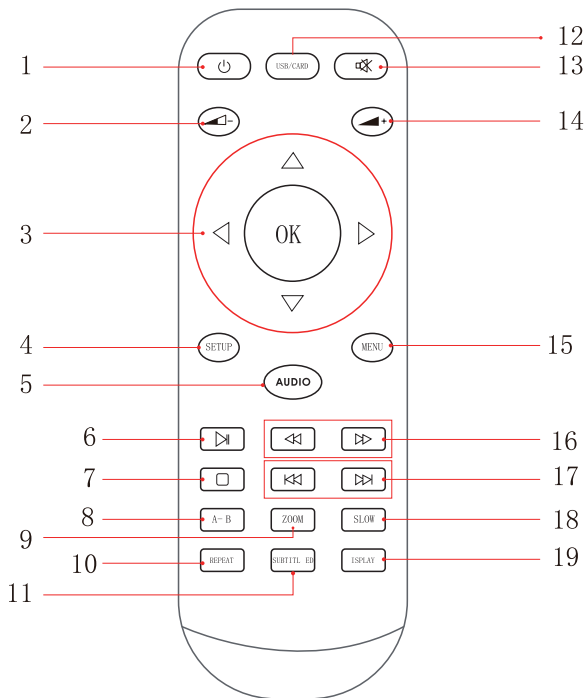

LCD ON/OFF	Turn the unit screen on and off.
VOL -/VOL +	Controls the volume up or down.
STOP	Press to stop current video.
MENU	Press to return to the root menu for DVD.
MODE	Press repeatedly to switch the mode for AV IN or DVD.
SETUP	Press to enter the setup menu, then use the direction keys and OK to set the system menu.
Direction Keys	Use direction keys for: previous/next, fast forward/fast rewind.
OK	Press to enter the selected item or the choice.
DVD/USB/SD	Press repeatedly to switch input source: Disc/USB mode/SD card.
FED/REV	Press to achieve fast/rewind forward.

Remote Control Instruction



1. Turn the unit on and off
2. Decrease volume, minimum to 0
3. Selection/Enter, Frame-by-frame
 - To select: Press up, down, left, or right ([], [], [], [])
 - To enter: Press [OK]
 - Frame forward/ Frame backward:
(while paused) press left or right ([], [])
4. **SETUP:** Show Setup menu directly (except the AV mode)
5. **AUDIO:** Press to switch left and right channels

6.  Play or pause the audio/ movie playback. Confirms the selection or press it to select the file to play
7.  Short press to stop the audio/ video/ photo playback
9. **ZOOM:** Short press to select 2X, 3X, 4X, 1/2, 1/3
10. **REPEAT:** Repeat the loaded disc
11. **SUBTITLE:** Change subtitle mode
12. **USB/CARD:** Switch between DVD, CARD and USB modes
13.  Mute the sound (Press again to activate the sound)
14.  Increase volume, maximum to 20
15. **MENU:** View the main menu on a loaded DVD
16.  Select fast forward/ rewind speed
17.  Play previous/next chapter/title/track
18. **SLOW:** Press to achieve 1/2, 1/4, 1/8, 1/16 times slow playback
19. **DISPLAY:** Turn on or off the LCD screen

Range of use

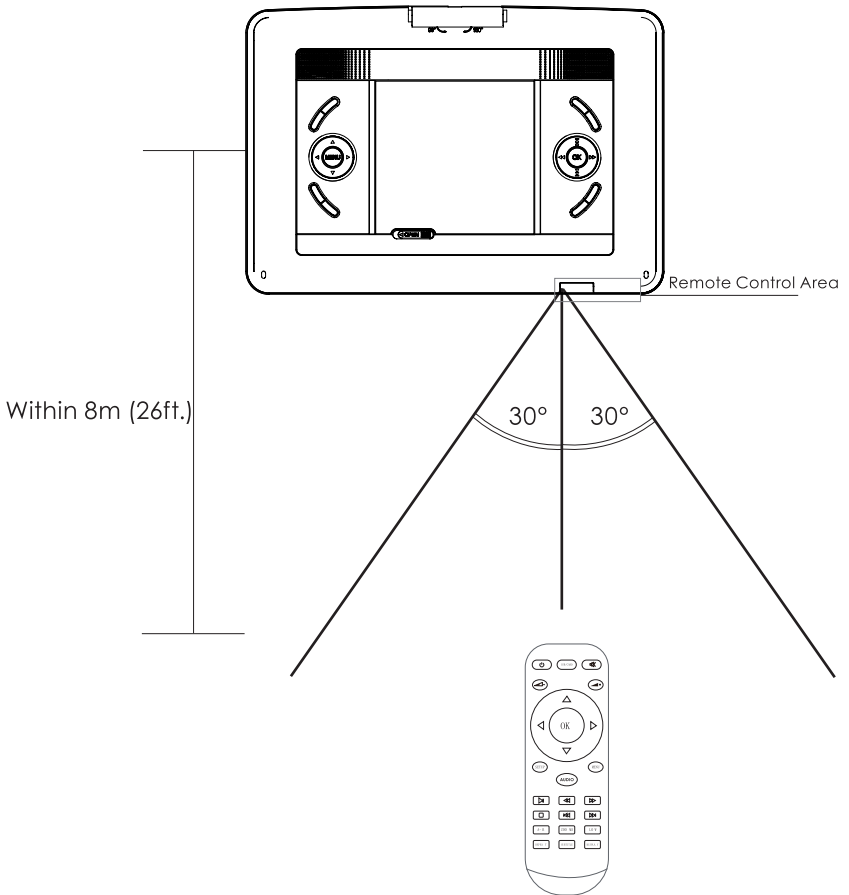

The distance and angles are approximate.
Within 8m (26ft.) in front
Within 30 degrees angle either left or right

CONNECTION

Enjoy Fun with a Game Controller

You can play multiple classic games with a game controller(not included in the package). Before playing, please download games via this website below.

<https://sourl.cn/XVcBpM>

Here are the instructions about how to play games on a DVD player:

1. Use your PC to download games from the attachment file.
2. Unzip the NES file folder to your PC, and copy the folder to a USB stick (16GB to 32GB).
3. Plug the USB stick into the right-side USB slot and plug the game joystick into the backside USB slot.
4. Turn on the player and press "USB/SD card", choose "USB" mode.
5. Find "NES_game" from the "menu" then select the game to start playing.
6. If you want to play other games, press the "SELECT" and "START" buttons for the joystick to exit back to the game menu.

Enjoy Fun with a Television

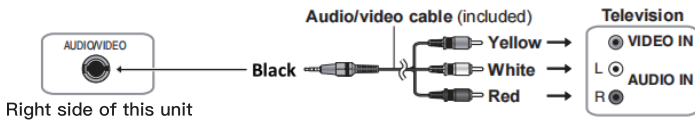

SETUP PAGE

Menu Operation

1. Press **[SETUP]** on the remote control or on the unit to show the setup menu.
2. Press **[LEFT]** / **[RIGHT]** to select an item. The submenu of the selected item will be instantly shown.
3. Press **[UP]** / **[DOWN]** to select an item in the submenu, then press **[OK]**/ **[ENTER]** to enter. Use **[UP]** / **[DOWN]** to select an option, then press **[OK]** / **[ENTER]** to confirm it or press **[LEFT]** to cancel.
4. Press **[UP]** / **[DOWN]** to continue to set other items in the submenu.
5. Press **[LEFT]** to go back to the superior menu of the current one.
6. Press **[SETUP]** again and press **[ENTER]** / **[OK]** to exit the setup menu.

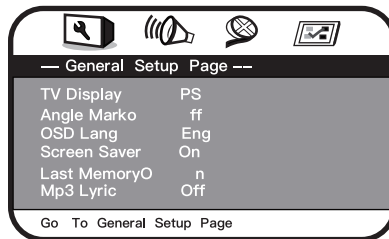

General Setup Page

[TV Display]

1. 4:3 Normal / PS PANSCAN

If the unit is connected to a conventional TV set, the wide-screen image will be displayed on the screen in its native aspect ratio with some part on the left and right cut off.

2. 4:3 Normal / LB LETTERBOX

If the unit is connected to a conventional TV set, the wide-screen image will be displayed in its native aspect ratio with black borders on the top and the bottom side.

3. 16:9 wide

Select this option if the unit is connected to a wide-screen TV set. The wide-screen image will be displayed in full screen in its native aspect ratio while the 4:3 image will be stretched out horizontally to fit in the screen.

[ANGLE MARK]

1. Set this item to ON. When a disc encoded with multiple camera angles is playing, the angle mark will display on the screen. Then you can view the video of different camera angles by pressing [ANGLE] on the remote control.

2. Set this item to OFF to disable this function.

NOTE: This function only works with those discs encoded with multiple camera angles.

[OSD LANGUAGE] (on-screen display language)

Set this on-screen display language in this item.

[SCREEN SAVER]

1. ON: If the image remains motionless on the screen, for several minutes, a screen saver will appear on the screen. You can press any key or button to wake it up.

2. OFF: Turn off the screen saver function.

[LAST MEMORY]

1. ON: Each time you turn off the unit or stop the disc, it will memorize the last play duration. Next time you turn on the unit and play the same disc, the unit will play from that memorized point.

2. OFF: Disable the last memory function.

[MP3 LYRIC]

If you want to show the lyrics of a song, please load lyrics and music as the same name in a USB or Memory card before performing this function.

1. Choose MP3 file.

2. Download the corresponding lyrics with the extension ".lrc" from the Internet or create it with lyric file editor (not included).

3. Rename the lyrics file. Make sure that the lyrics filename is the same as the music file name.

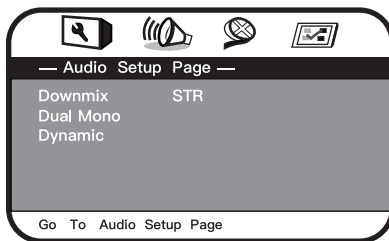

Audio Setup Page

The Audio menu allows you to change the audio setup of the DVD.

[Down mix] Set down mix to LT/RT, Stereo.

[Dual Mono] Set down Stereo, L-Mono, R-Mono or Mix-Mono.

[Dynamic] Full 3/4, 1/2, 1/4, OFF

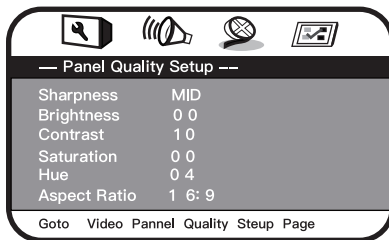

Panel Quality Setup

The video menu allows you to change the display properties of the DVD.

[Sharpness] Adjusts the screen sharpness.

[Brightness] Adjusts the screen brightness.

[Contrast] Adjusts the screen contrast.

[Saturation] Adjusts the screen saturation.

[Hue] Adjusts the screen hue.

[Aspect Ratio] Setup panel display to 16:9 or 4:3.

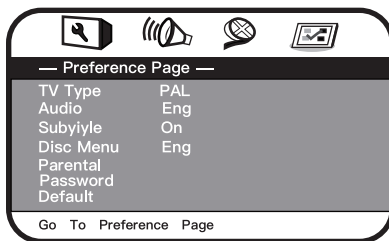

Preference Page

The preference menu option allows you to adjust the default DVD disc setting. (The setting is only available when no media is inside the unit.)

[TV Type] Set TV Type to PAL, AUTO, or NTSC.

[Audio] Set the default audio language.

[Subtitle] Set the subtitle language.

[Disc Menu] Set the disc menu language.

[Parental] When setting a rating level, a password screen is shown. Follow the on-screen instructions. Do not forget your password.

[Password] Enter the default password "0000" then set your password.

[Default] Return the portable DVD to factory default beyond the maximum output of the speaker in sound effects processing.

SPECIFICATIONS

DIVX Playback

DIVX is a video (movies and video) recording format, which is commonly known as AVI.

DIVX disc features high quality that is comparable with the DVD's and larger capacity. For example:

1.5H movie	In MPEG-1/2 format	In DivX
DVD(MPEG-2)	About 1.5-2GB	About 600-800MB
VCD (MPEG-1)	About 800MB-1G	About 600-800MB

Difference among MPEG 1, MPEG 2 and MPEG 4

	MPEG 1	MPEG 2	MPEG 4
Speed(kb/s)	1380kb/s (352*288)	6500kb/s	8800kb/s (720*576)
Quality	Good	Excelled	Perfect
Hardware	Low	Medium	High

Supported format for different files

File	Supported Format
Compatible Disc	CD-R, CD-RW, VCD, SVCD, CVD, DVD±R, DVD±RW
Audio	MP3, WMA, OGG, AAC (Bit rates: 32-192kbps)
Video	AVI, MPG, MP4, VOB, FLV, RMVB (Resolution must be within 720*576)
Picture	JPG
E-book	TXT(Code: ANSI)

Specification

Compatible DISC	CD, DVD, CD-R(RW), DVD±R, DVD±RW, VCD, SVCD(RW)
Frequency response	20HZ to 20KHZ
Video output	1 Vp-p75 Ohm unbalanced
Audio output	1.4 Vrms/10 kohm
Dynamic range	Better than 85dB
Laser	Semiconductor laser, Waver length:650
Power source	DC9-12V 1.5A
Battery Type	Li polymer

TROUBLESHOOTING

Before contacting the customer service, please kindly check by yourself with the following chart.

Troubleshooting	Solution
The player can't read discs	<ul style="list-style-type: none"> • Please clean the laser and DVDs with the alcohol first.(P2) • Ensure the disc is in the right format for our DVD player. Our player doesn't support Dolby, pirate, burnt and blu rays DVDs. • Find your product order and email to "Contact seller" (vp-service@iegeek.com)

The player doesn't work	<ul style="list-style-type: none">• Make sure the power switch has been set to the "ON" position.• Check connections to the AC adaptor or battery pack.• Check the status of the indicator light. Under the premise of power connection, if it's on, there is a problem with the motherboard; if it's off, there is a problem with the motherboard or power adapter.• Find your product order and email to "Contact seller" (vp-service@iegeek.com)
Picture is distorted	<ul style="list-style-type: none">• The disc might be damaged. Try another disc.• It is normal for some distortion to appear during forward or reverse scanning.
The player doesn't read MP4 on the USB or SD card	<p>DVD player supports MP4 files in your USB Drive/SD card, but you need to convert the formats first. You can download a converter, FormatFactory, to complete the conversion. Any questions please contact customer service for more help. (vp-service@iegeek.com)</p>

Remote controller doesn't work	<ul style="list-style-type: none">• Replace the battery (AAA battery).• All buttons fail: A problem with remote controller or receiver.• Individual buttons fail: Find your product order and email to "Contact seller" (vp-service@iegeek.com)• Note: The remote controller needs to be aimed directly at the front of the Video Player, within 8 m and 30 degrees(P7).
The game function doesn't work	<ul style="list-style-type: none">• Check the connection to the game controller. There is a USB port on the right of the device marked "Game".• Make sure the game you download is the one shown in the link below: https://sourl.cn/XVcBpM• Follow the correct steps to play(P8). Or contact customer service for more help. (vp-service@iegeek.com).
The player sound is too low.	<ul style="list-style-type: none">• Check that the two speakers of the player are working properly, cover one speaker with your hand, and check if the other speaker is sounding.• Check whether the disc you put in meets the specifications(P13). Our player does not support DTS, which is the audio track of Dolby Disc. Please try another disc(not pirate, burnt, Dolby and Blu-ray discs) to hear whether it will play louder.

No sound or distorted sound	<ul style="list-style-type: none">• The speaker is off if headphones are connected.• Make sure your DVD is placed properly and all cables are securely connected into the appropriate jack.• Audio may not be output due to how files were created.
Can't advance through a movie	You can't advance through the opening credits and warning information that appears at the beginning of movies because the disc is programmed to prohibit that action.
Other problem	Static discharges or other external interferences can cause the DVD player to malfunction. When this happens, disconnect the power plug and plug it back in. If the problem happened again, disconnect the device from main power and contact Customer Service or a repair shop.

WARRANTY

Our company provides customers with a warrant of **12 MONTHS** from the date of purchase.

Should you experience any problems not covered by the FAQ, please don't hesitate to email us at **vp-service@iegeek.com**

WARRANTY EXCLUSION

The warranty will not be valid if:

1. The product has not been installed, operated or maintained in accordance with the manufacturers operating instructions provided with the product.
2. The product has been used for purposes other than its intended function.
3. The product has been used for purposes other than household use.
4. The damage or malfunction of the product is caused by any of following conditions:
 - Incorrect voltage.
 - Accidents (including liquid or moisture damage).
 - Misuse or abuse of the product
 - Faulty or improper installation
 - Mains supply problems including power spikes or lightning damage
 - Infestation by insects
 - Tampering or modification of the product by persons other than authorized service person
 - Exposure to abnormally corrosive materials
 - Insertion of foreign objects into the unit
 - Used with accessories not pre-approved

WARNING

ENGLISH: PLEASE DO NOT EXPOSE THE MACHINE TO THE SUN DIRECTLY OR CLOSE TO THE FIRE, IT MAY CHANGE THE SHAPE OF THE MACHINE AND THE COLOR OF THE DISPLAY. IT IS NORMAL THAT THE MACHINE GOES HOT AFTER USING FOR A PERIOD OF TIME.

FRENCH: VEUILLEZ NE PAS EXPOSER LA MACHINE DIRECTEMENT AU SOLEIL OU PRÈS D'UN FEU, CELA POURRAIT DÉFORMER LA MACHINE ET ALTÉRER LA COULEUR DE L'ÉCRAN. IL EST NORMAL QUE LA MACHINE CHAUFFE APRÈS UNE CERTAINE PÉRIODE D'UTILISATION.

GERMAN: BITTE SETZEN SIE DIE MASCHINE NICHT DIREKTEM SONNENLICHT ODER FEUER AUS, DA DIES DIE FORM DER MASCHINE UND DIE FARBE DES DISPLAYS VERÄNDERN KANN. ES IST NORMAL, DASS DIE MASCHINE NACH EINER GEWISSEN NUTZUNGSDAUER HEIß WIRD.

SPANISH: POR FAVOR, NO EXPONGA LA MÁQUINA DIRECTAMENTE AL SOL NI CERCA DEL FUEGO, YA QUE PODRÍA DEFORMARSE Y CAMBIAR EL COLOR DE LA PANTALLA. ES NORMAL QUE LA MÁQUINA SE CALIENTE DESPUÉS DE UN TIEMPO DE USO.

ITALIAN: SI PREGA DI NON ESPORRE LA MACCHINA DIRETTAMENTE AL SOLE O VICINO AL FUOCO, POTREBBE DEFORMARSI E CAMBIARE IL COLORE DEL DISPLAY. È NORMALE CHE LA MACCHINA SI RISCALDI DOPO UN PERIODO DI UTILIZZO.

JAPANESE: 機械を直射日光や火のそばに置かないでください。機械の形状やディスプレイの色が変わる可能性があります。使用後に機械が熱くなるのは正常です。

Manufacturer: SHENZHEN GLOBALEBUY CO., LTD.

Room 102, Building D, Donghaiwang Industrial Zone, No.369 Bulong Road, Ma'antang Community, Bantian Street, Longgang District, Shenzhen, Guangdong, China
vp-service@iegeek.com



FR
Vous êtes responsable de remettre tous les appareils électroniques et électriques usagés à des points de collecte correspondants.
Pour en savoir plus :
www.quefairedemesdechets.fr



FR
Les piles et batteries se recyclent
A DÉPOSER EN MAGASIN
OU
A DÉPOSER EN DÉCHÈTÈRE

Points de collecte sur www.quefairedemesdechets.fr

Tiger-Zhou UG (haftungsbeschränkt) Leipzig HRB 37896 Shukowstr. 6 04347
Leipzig, Sachsen, Deutschland
Tiger-Zhou@web.de
+4915216791470

Sea&Mew Accounting Ltd
Electric Avenue Vision 25, London,
Enfield EN3 7GD
info@seamew.net
+447399648608

Made in China 株式会社神州

