

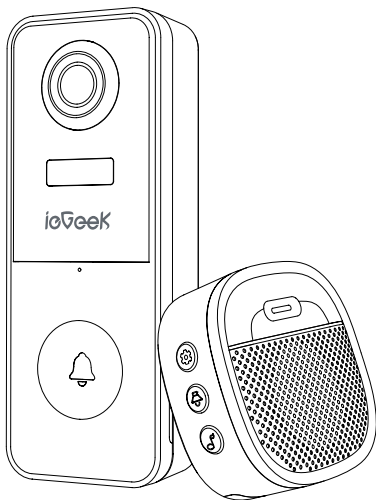

Wireless Video Doorbell

Quick Start Guide

Bell J10



Sales Email: service@iegeek.com



View Complete User Manual

Scan the QR code to subscribe and watch more step-by-step operation manual about ieGeek doorbell camera.

Validate your warranty within 7 days and get
3-year extended warranty on your
iegeek security products.



Email: service@iegeek.com

FCC Statement

This equipment has been tested and found to comply with the limits for a Class B digital device, pursuant to part 15 of the FCC rules. These limits are designed to provide reasonable protection against harmful interference in a residential installation.

This equipment generates, uses and can radiate radio frequency energy and, if not installed and used in accordance with the instructions, may cause harmful interference to radio communications. However, there is no guarantee that interference will not occur in a particular installation. If this equipment does cause harmful interference to radio or television reception, which can be determined by turning the equipment off and on, the user is encouraged to try to correct the interference by one or more of the following measures:

- Reorient or relocate the receiving antenna.
- Increase the separation between the equipment and receiver.
- Connect the equipment into an outlet on a circuit different from that to which the receiver is connected.
- Consult the dealer or an experienced radio/TV technician for help.

Responsible for compliance could void the user's authority to operate this equipment. (Example-use only shielded interface cables when connecting to computer or peripheral devices).

Any Changes or modifications not expressly approved by the party responsible for compliance could void the user's authority to operate the equipment.

This equipment complies with Part 15 of the FCC Rules. Operation is subject to the following two conditions:

1. This device may not cause harmful interference, and;
2. This device must accept any interference received, including interference that may cause undesired operation.

FCC Radiation Exposure Statement:

The equipment complies with FCC Radiation exposure limits set forth for uncontrolled environment. This equipment should be installed and operated with minimum distance 20cm between the radiator and your body.

(FCC ID: 2AUSP-BELLJ6)

CONTENTS

ENGLISH 1

FRANÇAIS 13

DEUTSCH 26

ESPAÑOL 39

ITALIANO 52

ENGLISH

01	What's in the box?	1
02	Meet the doorbell	2
03	Meet the chime	3
04	Charge your doorbell	4
05	App download	5
06	Set up doorbell	5
07	Pair with your indoor chime	8
08	Install Your doorbell	9
09	Trouble Shooting	11

01/What's in the box?

Please consult below checklist for all the components.

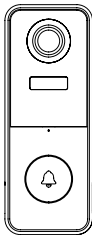

Video Doorbell
(with Bracket)



Indoor Chime

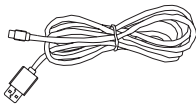

Charging Cable

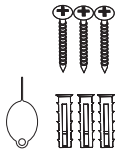

Screws & Tools

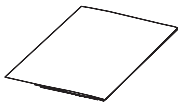

User Guide

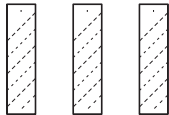

Double-sided Tape

02/Meet the doorbell

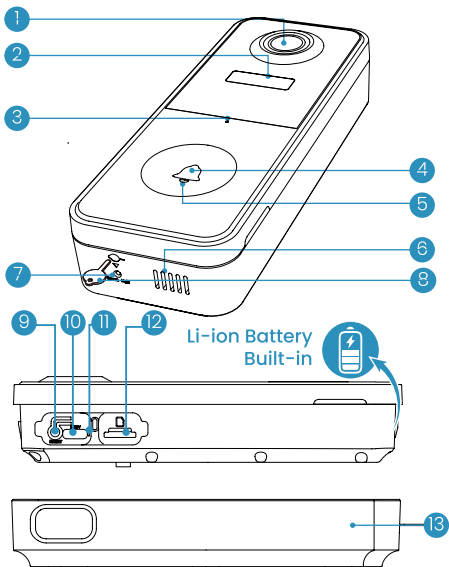

1	Lens	2	PIR Motion Sensor
3	Microphone	4	Doorbell Button (Power Button)

5	LED Indicator	6	Speaker
7	Unlock hole	8	Unlock Pin
9	Reset Button	10	Charging Port
11	Charging Indicator	12	Micro-SD Card Slot
13	Doorbell Bracket		

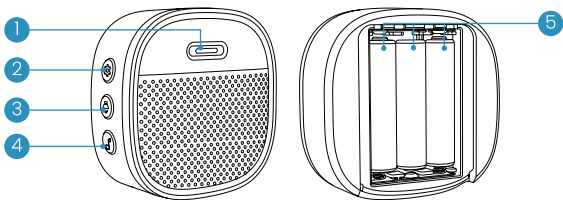

***When you receive the product, the doorbell and bracket are integrated.**

03/Meet the chime



1	LED Indicator	2	Setting
3	Volume Control	4	Select Ringtone
5	AAA Batteries		

04/Charge your doorbell

LED STATUS	INDICATION
 Solid red	Battery charging
 Solid blue	Fully charged

Compatible charger (not included): USB compatible mobile phone charger (DC 5V 1A~2A).

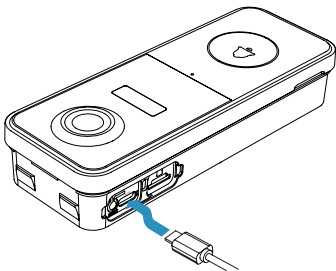

Battery Life: 1-2 months

Under laboratory environments, the wireless doorbell works 2 months with 20 triggers a day.

Tips: Battery life depends on temperature, PIR trigger frequency and battery aging factors.

05/App download

Search 'ieGeek Cam' in the APP Store or scan below QR codes to download the APP. (Also support 'CloudEdge' APP)



ieGeek Cam



ieGeek Cam

Please select your region and use your email address to register or log in to the APP.

06/Set up doorbell

6.1. Install Micro SD Card(Not included)

1. Use the included unlocking pin tool to insert into the small hole on the bottom.
2. Remove the doorbell from bracket.
3. Insert the Micro SD card into the card slot on the left side of the doorbell.

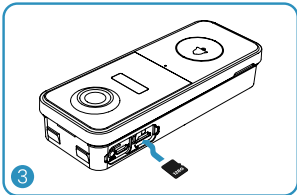
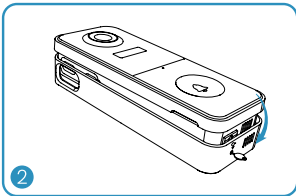
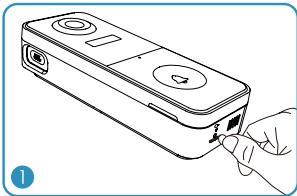

Notes for Micro SD Card

1. Please insert Micro SD Card before powering on, otherwise the Micro SD card can not be detected.
2. ieGeek doorbell supports Micro SD card up to 128GB.
3. Requirement Condition: Class 10 reading and writing speed and FAT32 file format (formatted before use).

6.2. Connect the Doorbell to Wifi

Press the doorbell button to activate it, and you will see the LED indicator flashes red (once per second). If not, press and hold reset button for 5 seconds to restore factory defaults.

Method 1: Bluetooth Set Up

1. On the Homepage, tap "Add" or "+" in the upper right corner, tap "Add Device".
2. If the Bluetooth of cellphone doesn't turn on, the app will show a pop-up, please allow it to turn on Bluetooth.

3. After Bluetooth turns on, the app will automatically search for devices that are on and not bound. Select the device you want to connect in the search list.







Method 2: Scan the QR Code

1. On the Homepage, tap "Add" or "+" in the upper right corner, tap "Add Device".

2. Choose Smart Doorbell(2.4G Wifi) and following the in-app instruction.

Tips:

- Please operate settings near your Wi-Fi router.
- Make sure your phone is connected to 2.4GHz Wi-Fi.
- Make sure the doorbell is turned on, and the LED indicator is flashing red. If not, press and hold RESET for 5 seconds.
- Make sure the Wi-Fi signal is good, and the Wi-Fi password is correct.

LED STATUS	INDICATION
 Solid red	Device is abnormal
 Flash red (once/sec)	Ready for Wi-Fi configuration
 Flash red (twice/sec)	Connecting to Wi-Fi
 Solid blue	Device is online
 Flash blue (once/sec)	Live-viewing doorbell cam
 Flash blue (twice/sec)	Firmware upgrading

07 / Pair with your indoor chime

When you receive the product, chime and the doorbell are connected by default. If you find the chime is not connected to the doorbell, you can connect it manually as follows:

1. Click the **SETTING** button on the chime, and the chime will be in pairing mode for 20 seconds, with its red LED flashing.

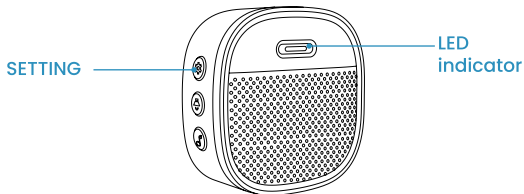

2. Press the doorbell button to send a pairing signal, and your chime will sound to react, together with its blue LED flashing. Chime pairing succeeds.

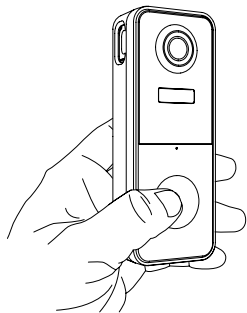

Chime rings & indicator flashes blue

08/Install Your doorbell

- Select location for your doorbell.

Select a location.

It is suggested to mount the doorbell at least 4 feet (120 cm) above the ground for optimal angle of view and best motion detection performance.

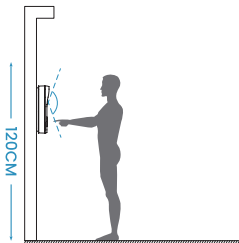

Mount your doorbell.

1. Release the rear mount using the unlock pin.

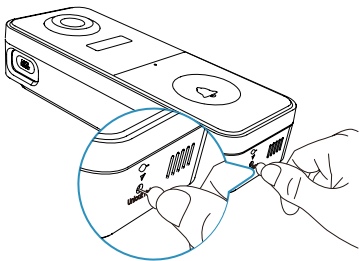

2. Mark the screw holes with the doorbell mount.
3. Mount the rear mount to your wall with screws and tools.

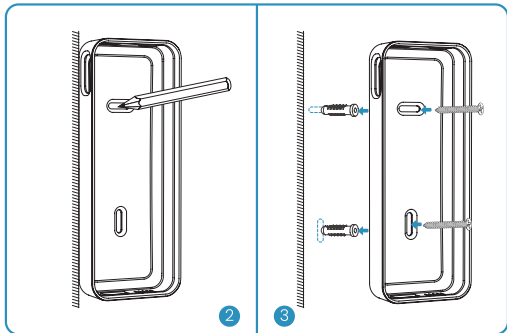

4. Adhesive tapes are optional to mount the doorbell on flat surfaces.
5. Attach the doorbell to its rear mount, and push the doorbell to lock up.

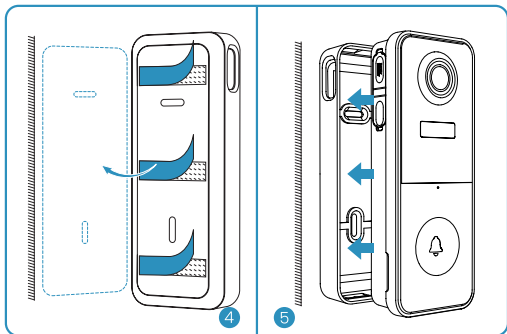

6. All set! Press the doorbell button to run a test.

Scan the QR Code to get detailed connection & installation video of ieGeek Doorbell.

If you encounter any questions, please contact us via email: service@iegeek.com.



09/Trouble Shooting

Q1: Is the video doorbell powered by battery?

A1: Yes, there is a Li-ion battery built-in. Thanks to the low power consumption technology, a full charge lasts for about 2 months in our lab test environment (Lab test condition: 10 events per day, 15 seconds video recording per event). When the temperature is too low, the power consumption rate will increase.

Q2: Does it support legacy hardwire power source?

A2: No, it doesn't.

Q3: Does the doorbell support 5GHZ WiFi?

A3: No, it only supports 2.4GHZ WiFi.

Q4: How many wireless chimes can be added to the doorbell?

A4: You can add several wireless chimes to work with your video doorbell.

Q5: Does it support customized Motion Detection Zones.

A5: Yes it does. You can customize the detection zone in the doorbell settings.

Q6: Does the doorbell support cloud storage?

A6: Your doorbell support local video storage by Micro SD card. And you can also activate free cloud storage service in the App. Free cloud storage supports 6s video recording and the storage time is seven days.

Set path: Setting---Cloud Storage Service---Basic Cloud Storage---Scroll to the bottom of the page---Tap to on

Q7: How to install Micro SD card?

A7: Use the included pin to insert into the small hole at the bottom of the doorbell to remove the doorbell from the bracket. The SD card slot is on the left side.

(The doorbell and the bracket are integrated when you receive it)

FRANÇAIS

01	Que contient la boîte?.....	14
02	Découvrez la sonnette.....	15
03	Découvrez le carillon.....	16
04	Chargez votre sonnette.....	17
05	Téléchargement de l'application.....	18
06	Installation de la sonnette.....	18
07	Associez-le à votre carillon intérieur.....	21
08	Installez votre sonnette.....	22
09	Dépannage.....	24

01/Que contient la boîte?

Veillez consulter la liste de contrôle ci-dessous pour tous les composants.

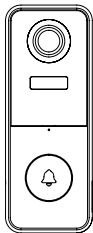

Sonnette Vidéo
(avec support)



Carillon Intérieur

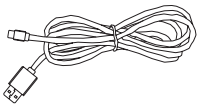

Câble de Chargement



Vis et Outils

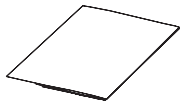

Guide de l'utilisateur

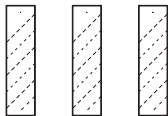

Ruban Adhésif Double
Face

02 / Découvrez la sonnette

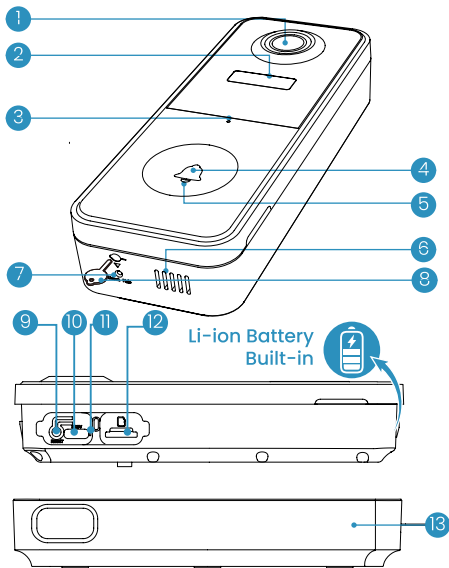

1	Lentille	2	Capteur de Mouvement PIR
3	Microphone	4	Bouton de Sonnette (bouton d'alimentation)

5	Indicateur LED	6	Haut-parleur
7	Trou de Déverrouillage	8	Broche de Déverrouillage
9	Bouton de Réinitialisation	10	Port de Charge
11	Indicateur de charge	12	Emplacement pour carte Micro-SD
13	Support de Sonnette		

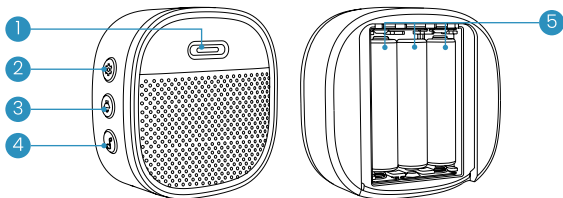

*Lorsque vous recevez le produit, la sonnette et le support sont intégrés.

03/Découvrez le carillon



1	Indicateur LED	2	Réglage
3	Contrôle du Volume	4	Sélection de la Sonnerie
5	Piles AAA		

04/chargez votre sonnette

ÉTAT LED	INDICATION
 Rouge fixe	Chargement de la batterie
 Bleu fixe	Entièrement chargé

Chargeur compatible (non inclus): Chargeur de téléphone portable compatible USB (DC 5V 1A-2A)

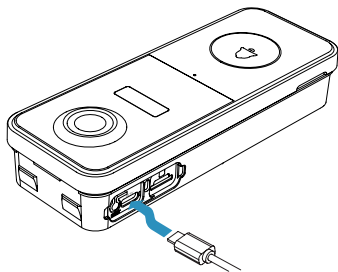

Autonomie de la batterie: 1 à 2 mois

Dans des environnements de laboratoire, la sonnette sans fil fonctionne 2 mois avec 20 déclencheurs par jour.

Conseils: La durée de vie de la batterie dépend de la température, de la fréquence de déclenchement PIR et des facteurs de vieillissement de la batterie.

05/Téléchargement de l'application

Recherchez « ieGeek Cam » dans l'App Store ou scannez les codes QR ci-dessous pour télécharger l'application. (Prend également en charge l'application « CloudEdge »)



ieGeek Cam



ieGeek Cam

Veillez sélectionner votre région et utiliser votre adresse e-mail pour vous inscrire ou vous connecter à l'application.

06/Installation de la sonnette

6.1. Installation de la carte Micro SD (non incluse)

1. Utilisez l'outil de déverrouillage fourni pour l'insérer dans le petit trou en bas.
2. Retirez la sonnette du support.
3. Insérez la carte Micro SD dans la fente pour carte sur le côté gauche de la sonnette.

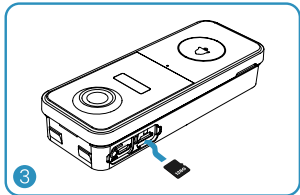
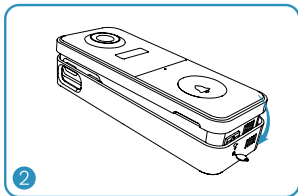
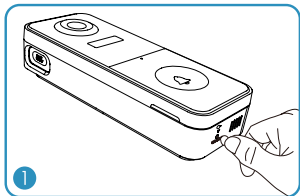

Remarques sur la carte Micro SD

1. Veuillez insérer la carte Micro SD avant la mise sous tension, sinon la carte Micro SD ne pourra pas être détectée.
2. La sonnette ieGeek prend en charge les cartes Micro SD jusqu'à 128 Go.
3. Condition requise : vitesse de lecture et d'écriture de classe 10 et format de fichier FAT32 (formaté avant utilisation).

6.2. Connecter la sonnette au Wi-Fi

Appuyez sur le bouton de la sonnette pour l'activer, et vous verrez le voyant LED clignoter en rouge (une fois par seconde). Sinon, appuyez sur le bouton de réinitialisation et maintenez-le enfoncé pendant 5 secondes pour restaurer les paramètres d'usine.

Méthode 1: Configuration du Bluetooth

1. Sur la page d'accueil, appuyez sur « Ajouter » ou « + » dans le coin supérieur droit, appuyez sur « Ajouter un appareil ».
2. Si le Bluetooth du téléphone portable ne s'active pas,

l'application affichera une fenêtre contextuelle, veuillez l'autoriser à activer le Bluetooth.

3. Une fois le Bluetooth activé, l'application recherchera automatiquement les appareils allumés et non liés. Sélectionnez l'appareil que vous souhaitez connecter dans la liste de recherche.







Méthode 2 : Scannez le code QR

1. Sur la page d'accueil, appuyez sur « Ajouter » ou « + » dans le coin supérieur droit, appuyez sur « Ajouter un appareil ».

2. Choisissez Smart Doorbell (Wifi 2,4 G) et suivez les instructions de l'application.

Conseils:

- Veuillez effectuer les réglages à proximité de votre routeur Wi-Fi.
- Assurez-vous que votre téléphone est connecté au Wi-Fi 2,4 GHz.
- Assurez-vous que la sonnette est allumée et que le voyant LED clignote en rouge. Si ce n'est pas le cas, appuyez sur RESET et maintenez-le enfoncé pendant 5 secondes.
- Assurez-vous que le signal Wi-Fi est bon et que le mot de passe Wi-Fi est correct

ÉTAT DES LED	INDICATION
 Rouge fixe	L'appareil est anormal
 Clignote en rouge (une fois/s)	Prêt pour la configuration Wi-Fi
 Clignote en rouge (deux fois/s)	Connexion au Wi-Fi
 Bleu fixe	L'appareil est en ligne
 Clignote en bleu (une fois/s)	Visualisation en direct de la sonnette vidéo
 Clignote en bleu (deux fois/s)	Mise à niveau du micrologiciel

07 / Associez-le à votre carillon intérieur

Lorsque vous recevez le produit, le carillon et la sonnette sont connectés par défaut. Si vous constatez que le carillon n'est pas connecté à la sonnette, vous pouvez le connecter manuellement comme suit:

1. Cliquez sur le bouton **RÉGLAGE** du carillon. Le carillon sera en mode appairage pendant 20 secondes, avec sa LED rouge clignotante.

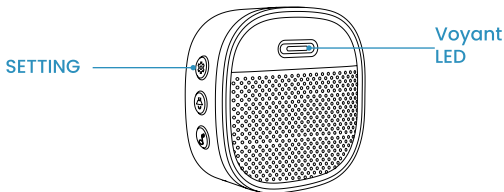

2. Appuyez sur le bouton de la sonnette pour envoyer un signal d'appairage. Votre carillon émettra alors un son et sa LED bleue clignotera. L'appairage du carillon est réussi.

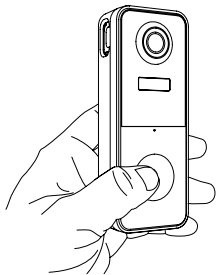

Le carillon sonne et le voyant clignote en bleu

08/Installez votre sonnette

- Sélectionnez l'emplacement de votre sonnette.

Sélectionnez un emplacement.

Il est suggéré de monter la sonnette à au moins 120 cm au-dessus du sol pour un angle de vue optimal et les meilleures performances de détection de mouvement.

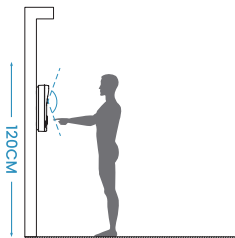

Montez votre sonnette.

1. Libérez le support arrière à l'aide de la goupille de déverrouillage.

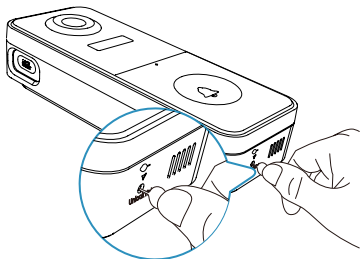

2. Marquez les trous de vis avec le support de sonnette.
3. Montez le support arrière sur votre mur avec des vis et des outils.

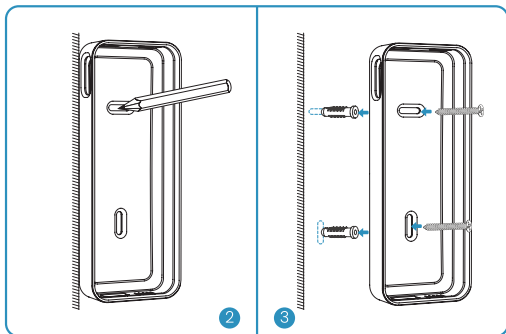

4. Des rubans adhésifs sont facultatifs pour monter la sonnette sur des surfaces planes.
5. Fixez la sonnette à son support arrière et poussez la sonnette pour la verrouiller.

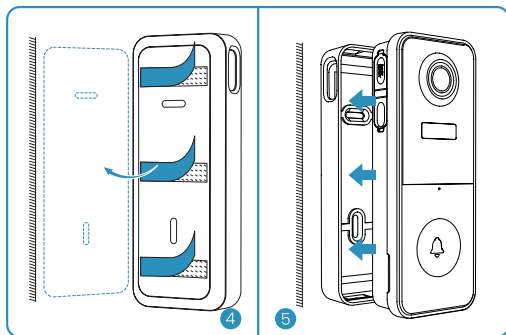

6. C'est prêt ! Appuyez sur le bouton de la sonnette pour effectuer un test.

Scannez le code QR pour obtenir une vidéo détaillée de connexion et d'installation de la sonnette ieGeek.

Si vous avez des questions, veuillez nous contacter par e-mail: service@iegeek.com.



09/Dépannage

Q1: La sonnette vidéo est-elle alimentée par batterie?

A1: Oui, il y a une batterie Li-ion intégrée. Grâce à la technologie à faible consommation d'énergie, une charge complète dure environ 2 mois dans notre environnement de test en laboratoire (conditions de test en laboratoire : 10 événements par jour, 15 secondes d'enregistrement vidéo par événement). Lorsque la température est trop basse, le taux de consommation d'énergie augmente.

Q2: Prend-elle en charge la source d'alimentation filaire héritée?

A2: Non, ce n'est pas le cas.

Q3: La sonnette prend-elle en charge le Wi-Fi 5 GHz?

A3: Non, elle ne prend en charge que le Wi-Fi 2,4 GHz.

Q4: Combien de carillons sans fil peuvent être ajoutés à la sonnette?

A4: Vous pouvez ajouter plusieurs carillons sans fil pour fonctionner avec votre sonnette vidéo.

Q5: Prend-il en charge les zones de détection de mouvement personnalisées?

A5: Oui, c'est le cas. Vous pouvez personnaliser la zone de détection dans les paramètres de la sonnette.

Q6: La sonnette prend-elle en charge le stockage dans le cloud?

A6: Votre sonnette prend en charge le stockage vidéo local par carte Micro SD. Et vous pouvez également activer le service de stockage cloud gratuit dans l'application. Le stockage cloud gratuit prend en charge l'enregistrement vidéo de 6 s et la durée de stockage est de sept jours.

Définir le chemin: Paramètres --- Service de stockage cloud -- Stockage cloud de base -- Faites défiler vers le bas de la page -- Appuyez pour activer

Q7: Comment installer la carte Micro SD?

A7: Utilisez la broche fournie pour l'insérer dans le petit trou au bas de la sonnette afin de retirer la sonnette du support. La fente pour carte SD se trouve sur le côté gauche.
(La sonnette et le support sont intégrés lorsque vous la recevez)

DEUTSCH

01	Was ist in der Box?	27
02	Lernen Sie die Türklingel kennen	28
03	Lernen Sie das Klingeln kennen	29
04	Laden Sie Ihre Türklingel auf	30
05	App-Download	31
06	Türklingel einrichten	31
07	Koppeln mit Ihrer Innenklingel	34
08	Installieren Sie Ihre Türklingel	35
09	FAQ	38

01/Was ist in der Box?

Bitte beachten Sie die unten stehende Checkliste für alle Komponenten.

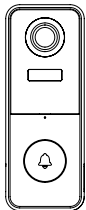

Video-Türklingel
(mit Halterung)



Innenklingel

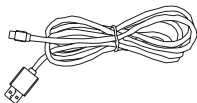

Ladekabel

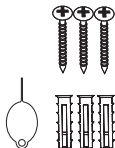

Schrauben und
Werkzeuge

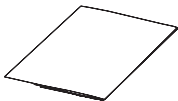

Benutzerhandbuch

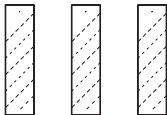

Doppelseitiges
Klebeband

02/Lernen Sie die Türklingel kennen

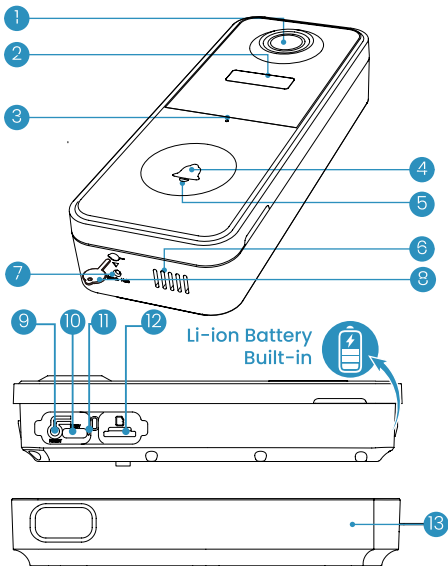

1	Linse	2	PIR-Bewegungssensor
3	Mikrofon	4	Klingeltaste (Einschalttaste)
5	LED-Anzeige	6	Lautsprecher
7	Entriegelungsloch	8	Entriegelungsstift
9	Reset-Taste	10	Ladeanschluss
11	Ladeanzeige	12	Micro-SD-Kartensteckplatz
13	Türklingel Halterung		

*Wenn Sie das Produkt erhalten, sind die Türklingel und die Halterung integriert.

03/Lernen Sie das Klingeln kennen

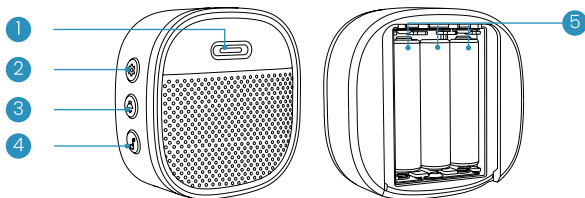

1	LED-Anzeige	2	Aufstellen
3	Lautstärkeregelung	4	Klingelton auswählen
5	AAA-Batterien		

04/Laden Sie Ihre Türklingel auf

LED-STATUS	ANZEIGE
 Durchgängig rot	Batterie wird geladen
 Durchgängig blau	Vollständig aufgeladen

Kompatibles Ladegerät (nicht im Lieferumfang enthalten): USB-kompatibles Handy-Ladegerät (DC 5V 1A~2A)

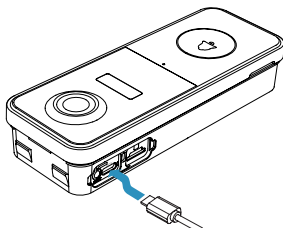

Batterielebensdauer: 1-2 Monate

Unter Laborbedingungen funktioniert die drahtlose Türklingel 2 Monate lang mit 20 Auslösungen pro Tag.

Tipps: Die Batterielebensdauer hängt von der Temperatur, der PIR-Auslösefrequenz und den Alterungsfaktoren der Batterie ab.

05/App-Download

Suchen Sie im App Store nach „ieGeek Cam“ oder scannen Sie die untenstehenden QR-Codes, um die App herunterzuladen. (Unterstützt auch die App „CloudEdge“)



ieGeek Cam



ieGeek Cam

Bitte wählen Sie Ihre Region aus und verwenden Sie Ihre E-Mail-Adresse, um sich zu registrieren oder bei der App anzumelden.

06/Türklingel einrichten

6.1. Micro-SD-Karte installieren (nicht im Lieferumfang enthalten)

1. Verwenden Sie den mitgelieferten Entriegelungsstift, um ihn in das kleine Loch an der Unterseite einzuführen.
2. Nehmen Sie die Türklingel von der Halterung ab.
3. Stecken Sie die Micro-SD-Karte in den Kartensteckplatz auf der linken Seite der Türklingel.

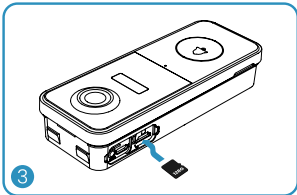
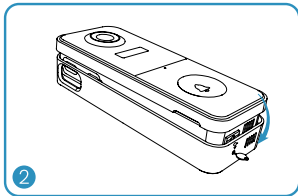
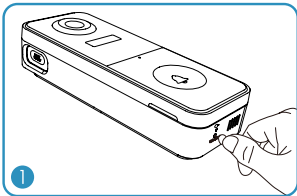

Hinweise zur Micro-SD-Karte

1. **Bitte** stecken Sie die Micro-SD-Karte vor dem Einschalten ein, da sie sonst nicht erkannt werden kann.
2. Die ieGeek-Türklingel unterstützt Micro-SD-Karten mit bis zu 128 GB.
3. Voraussetzung: Lese- und Schreibgeschwindigkeit der Klasse 10 und FAT32-Dateiformat (vor Gebrauch formatiert).

6.2 Türklingel mit WLAN verbinden

Drücken Sie die Türklingeltaste, um sie zu aktivieren. Die LED-Anzeige blinkt dann rot (einmal pro Sekunde). Wenn nicht, halten Sie die Reset-Taste 5 Sekunden lang gedrückt, um die Werkseinstellungen wiederherzustellen.

Methode 1: Bluetooth einrichten

1. Tippen Sie auf der Homepage oben rechts auf „Hinzufügen“ oder „+“ und dann auf „Gerät hinzufügen“.
2. Wenn sich Bluetooth auf dem Mobiltelefon nicht einschalten

lässt, zeigt die App ein Popup an. Bitte lassen Sie Bluetooth einschalten.

3. Nachdem Bluetooth eingeschaltet wurde, sucht die App automatisch nach eingeschalteten und nicht verbundenen Geräten. Wählen Sie das Gerät, das Sie verbinden möchten, in der Suchliste aus.

Methode 2: Scannen Sie den QR-Code

1. Tippen Sie auf der Homepage oben rechts auf „Hinzufügen“ oder „+“ und dann auf „Gerät hinzufügen“.

2. Wählen Sie Smart Doorbell (2,4-G-WLAN) und folgen Sie den Anweisungen in der App.

Tipps:

- Bitte nehmen Sie die Einstellungen in der Nähe Ihres WLAN-Routers vor.
- Stellen Sie sicher, dass Ihr Telefon mit dem 2,4-GHz-WLAN verbunden ist.
- Stellen Sie sicher, dass die Türklingel eingeschaltet ist und die LED-Anzeige rot blinkt. Wenn nicht, halten Sie RESET 5 Sekunden lang gedrückt.
- Stellen Sie sicher, dass das WLAN-Signal gut ist und das WLAN-Passwort korrekt ist.

LED-STATUS	ANWEISEN
○ Durchgängig rot	Gerät ist nicht normal
○ Rot blinkend (einmal/Sek)	Bereit für WLAN-Konfiguration.
○ Rot blinkend (zweimal/Sek.)	Verbindung mit WLAN wird hergestellt
○ Durchgängig blau	Gerät ist online

 Blau blinkend (einmal/Sek.)	Live-Ansicht der Türklingelkamera
 Blau blinkend (zweimal/Sek.)	Firmware-Aktualisierung

07 / Koppeln mit Ihrer Innenklingel

Wenn Sie das Produkt erhalten, sind Klingel und Türklingel standardmäßig verbunden. Wenn Sie feststellen, dass die Klingel nicht mit der Türklingel verbunden ist, können Sie sie wie folgt manuell verbinden:

1. Klicken Sie auf die Schaltfläche **AUFSTELLEN** auf der Klingel. Die Klingel befindet sich dann 20 Sekunden lang im Koppelungsmodus, wobei die rote LED blinkt.

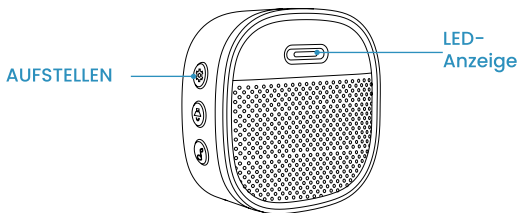

2. Drücken Sie die Türklingeltaste, um ein Koppelungssignal zu senden. Ihre Klingel gibt einen Ton ab und die blaue LED blinkt. Die Klingelkopplung ist erfolgreich.

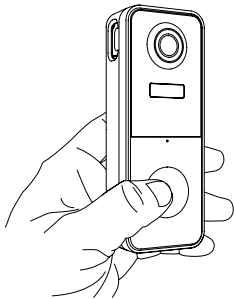

Klingel klingelt und die Anzeige blinkt blau

08/Installieren Sie Ihre Türklingel

- Wählen Sie einen Standort für Ihre Türklingel.

Wählen Sie einen Standort.

Es wird empfohlen, die Türklingel mindestens 120 cm über dem Boden zu montieren, um einen optimalen Blickwinkel und eine optimale Bewegungserkennungsleistung zu erzielen.

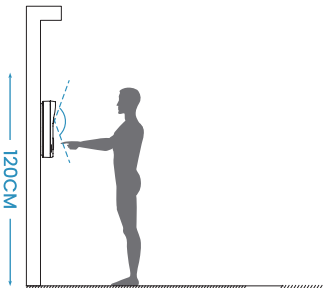

Montieren Sie Ihre Türklingel.

1. Lösen Sie die hintere Halterung mit dem Entriegelungsstift.

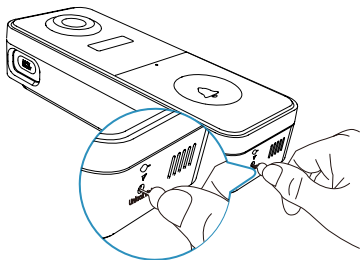

2. Markieren Sie die Schraubenlöcher mit der Türklingelhalterung.

3. Montieren Sie die hintere Halterung mit Schrauben und Werkzeug an Ihrer Wand.

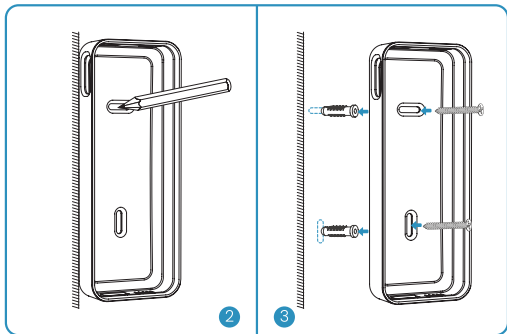

4. Adhesive tapes are optional to mount the doorbell on flat surfaces.

5. Attach the doorbell to its rear mount, and push the doorbell to lock up.

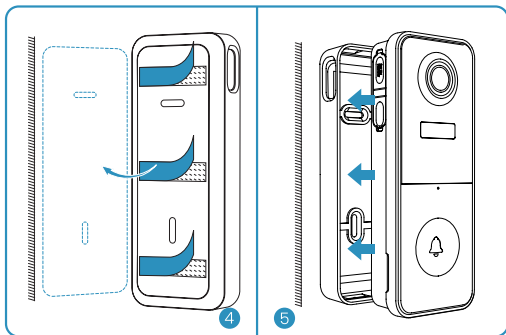

6. Fertig! Drücken Sie die Türklingeltaste, um einen Test durchzuführen.

Scannen Sie den QR-Code, um ein detailliertes Verbindungs- und Installationsvideo der ieGeek-Türklingel zu erhalten.

Wenn Sie Fragen haben, kontaktieren Sie uns bitte per E-Mail: service@iegeek.com.



09/FAQ

F1: Wird die Video-Türklingel batteriebetrieben?

A1: Ja, es ist ein Lithium-Ionen-Akku eingebaut. Dank der Technologie mit geringem Stromverbrauch hält eine volle Ladung in unserer Labortestumgebung etwa 2 Monate (Labortestbedingungen: 10 Ereignisse pro Tag, 15 Sekunden Videoaufzeichnung pro Ereignis). Wenn die Temperatur zu niedrig ist, steigt der Stromverbrauch.

F2: Unterstützt sie herkömmliche kabelgebundene Stromquellen?

A2: Nein.

F3: Unterstützt die Türklingel 5-GHz-WLAN?

A3: Nein, sie unterstützt nur 2,4-GHz-WLAN.

F4: Wie viele drahtlose Klingeln können der Türklingel hinzugefügt werden?

A4: Sie können mehrere drahtlose Klingeln hinzufügen, die mit Ihrer Video-Türklingel funktionieren.

F5: Unterstützt sie benutzerdefinierte Bewegungserkennungszonen?

A5: Ja, das tut sie. Sie können die Erkennungszone in den Türklingeleinstellungen anpassen.

F6: Unterstützt die Türklingel Cloud-Speicher?

A6: Ihre Türklingel unterstützt die lokale Videospeicherung per Micro-SD-Karte. Außerdem können Sie in der App den kostenlosen Cloud-Speicherdienst aktivieren. Der kostenlose Cloud-Speicher unterstützt 6-sekündige Videoaufzeichnungen und die Speicherdauer beträgt sieben Tage.

Pfad festlegen: Einstellungen---Cloud-Speicherdienst---Einfacher Cloud-Speicher---Zum Ende der Seite scrollen---Zum Einschalten tippen

F7: Wie installiere ich die Micro-SD-Karte?

A7: Stecken Sie den mitgelieferten Stift in das kleine Loch an der Unterseite der Türklingel, um die Türklingel von der Halterung zu entfernen. Der SD-Kartensteckplatz befindet sich auf der linken Seite.

(Die Türklingel und die Halterung sind bei Erhalt einteilig.)

ESPAÑOL

01	¿Qué hay en la caja?	40
02	Conozca el timbre	41
03	Conozca el timbre	42
04	Carga tu timbre.....	43
05	Descarga de la aplicación.....	44
06	Configurar el timbre.....	44
07	Vincúlelo con su timbre interior	47
08	Instala tu timbre.....	48
09	Solución de problemas	50

01/¿Qué hay en la caja?

Consulte la lista de verificación a continuación para ver todos los componentes.

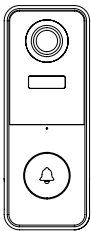

Timbre con video
(con soporte)



Tono de llamada

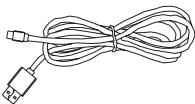

Cable de carga

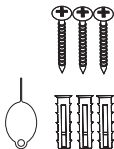

Tornillos y
herramientas

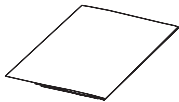

Guía del usuario

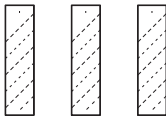

Cinta adhesiva de
doble cara

02/Conozca el timbre

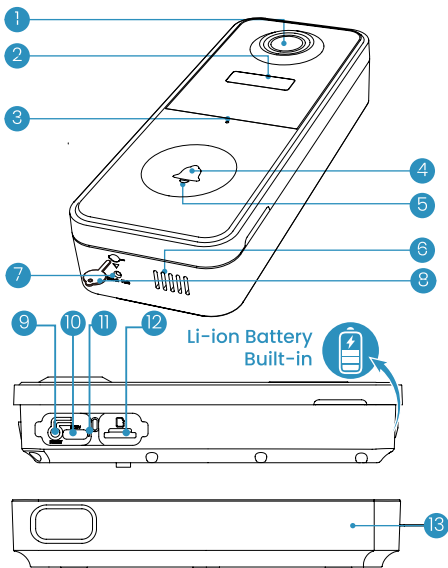

1	Lente	2	Sensor de Movimiento PIR
3	Micrófono	4	Botón del Timbre (botón de encendido)

5	Indicador LED	6	Altavoz
7	Orificio de Desbloqueo	8	Desbloquear Pin
9	Botón de Reinicio	10	Puerto de Carga
11	Indicador de Carga	12	Ranura para tarjeta Micro-SD
13	Soporte para Timbre		

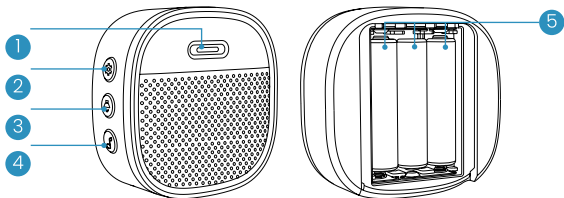

*Cuando recibe el producto, el timbre y el soporte están integrados.

03/Conozca el timbre



1	Indicador LED	2	Configuración
3	Control de volumen	4	Seleccionar tono de llamada
5	Pilas AAA		

04/ Carga tu timbre

ESTADO DEL LED	INDICACIÓN
 Rojo fijo	Batería cargándose
 Azul fijo	Completamente cargado

Cargador compatible (no incluido): Cargador de teléfono móvil compatible con USB (CC 5V 1A~2A)

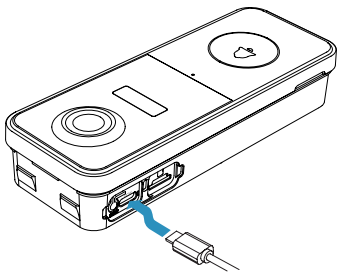

Duración de la batería: 1-2 meses

En entornos de laboratorio, el timbre inalámbrico funciona 2 meses con 20 activaciones al día.

Consejos: La duración de la batería depende de la temperatura, la frecuencia de activación del PIR y los factores de envejecimiento de la batería.

05 / Descarga de la aplicación

Busca "ieGeek Cam" en la tienda de aplicaciones o escanea los códigos QR que aparecen a continuación para descargar la aplicación (también es compatible con la aplicación "CloudEdge")



ieGeek Cam



ieGeek Cam

Seleccione su región y utilice su dirección de correo electrónico para registrarse o iniciar sesión en la aplicación.

06 / Configurar el timbre

6.1 Instalar la tarjeta Micro SD (no incluida)

1. Utilice la herramienta de desbloqueo incluida para insertarla en el pequeño orificio de la parte inferior.
2. Retire el timbre del soporte.
3. Inserte la tarjeta Micro SD en la ranura para tarjetas del lado izquierdo del timbre.

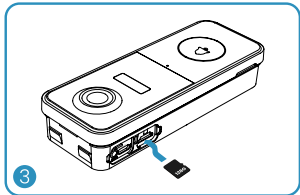
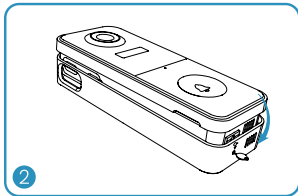
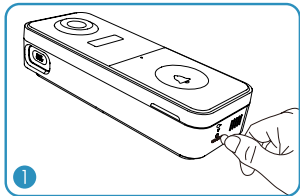

Notas para la tarjeta Micro SD

1. Inserte la tarjeta Micro SD antes de encender el dispositivo; de lo contrario, no se podrá detectar.
2. El timbre ieGeek admite tarjetas Micro SD de hasta 128 GB.
3. Requisitos: velocidad de lectura y escritura de clase 10 y formato de archivo FAT32 (formateado antes de su uso).

6.2. Conectar el timbre a Wi-Fi

Presione el botón del timbre para activarlo y verá que el indicador LED parpadea en rojo (una vez por segundo). De lo contrario, mantenga presionado el botón de reinicio durante 5 segundos para restablecer los valores predeterminados de fábrica.

Método 1: Configuración de Bluetooth

1. En la página de inicio, toque "Agregar" o "+" en la esquina superior derecha, toque "Agregar dispositivo".
2. Si el Bluetooth del teléfono celular no se enciende, la aplicación

mostrará una ventana emergente, permita que se encienda el Bluetooth.

3. Una vez que se active el Bluetooth, la aplicación buscará automáticamente dispositivos que estén encendidos y no vinculados. Seleccione el dispositivo que desea conectar en la lista de búsqueda.





Método 2: Escanee el código QR

1. En la página de inicio, toque "Agregar" o "+" en la esquina superior derecha, toque "Agregar dispositivo".

2. Elija Smart Doorbell (Wifi 2.4G) y siga las instrucciones de la aplicación.

Consejos:

- Utilice la configuración cerca de su enrutador Wi-Fi.
- Asegúrese de que su teléfono esté conectado a Wi-Fi de 2,4 GHz.
- Asegúrese de que el timbre esté encendido y que el indicador LED esté parpadeando en rojo. De lo contrario, mantenga presionado RESET durante 5 segundos.
- Asegúrese de que la señal de Wi-Fi sea buena y que la contraseña de Wi-Fi sea correcta.

ESTADO DEL LED	INDICACIÓN
 Rojo fijo	El dispositivo no funciona correctamente
 Parpadeo rojo (una vez por segundo)	Listo para la configuración de Wi-Fi
 Parpadeo rojo (dos veces por segundo)	Conectándose a Wi-Fi
 Azul fijo	El dispositivo está en línea
 Parpadeo azul (una vez por segundo)	Cámara de timbre con visualización en vivo
 Parpadeo azul (dos veces por segundo)	Actualización de firmware

07 Vincúlelo con su timbre interior

Cuando recibe el producto, el timbre y el timbre interior están conectados de forma predeterminada. Si descubre que el timbre no está conectado al timbre, puede conectarlo manualmente de la siguiente manera:

1. Haga clic en el botón **CONFIGURACIÓN** del timbre interior y este estará en modo de emparejamiento durante 20 segundos, con su LED rojo parpadeando.

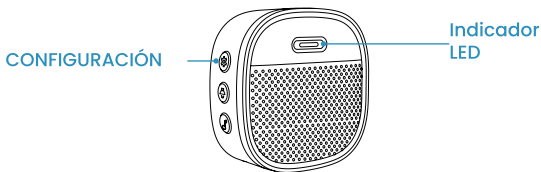

2. Pulse el botón del timbre para enviar una señal de emparejamiento y el timbre interior sonará para reaccionar, junto con su LED azul parpadeando. El emparejamiento del timbre se ha realizado correctamente.

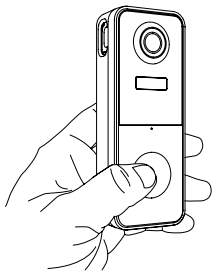

El timbre interior suena y el indicador parpadea en azul

08/Instala tu timbre

- Selecciona la ubicación para tu timbre.

Selecciona una ubicación.

Se recomienda montar el timbre al menos a 120 cm (4 pies) del suelo para obtener un ángulo de visión óptimo y un mejor rendimiento de detección de movimiento.

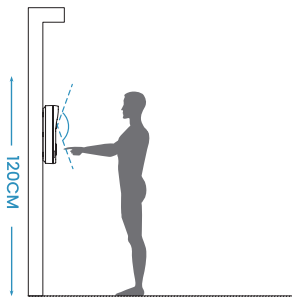

Monta tu timbre.

1. Suelta el soporte trasero con el pasador de desbloqueo.

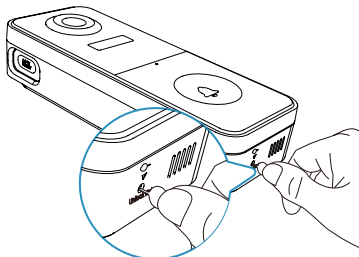

2. Marca los orificios para tornillos con el soporte del timbre.
3. Monta el soporte trasero en la pared con tornillos y herramientas.

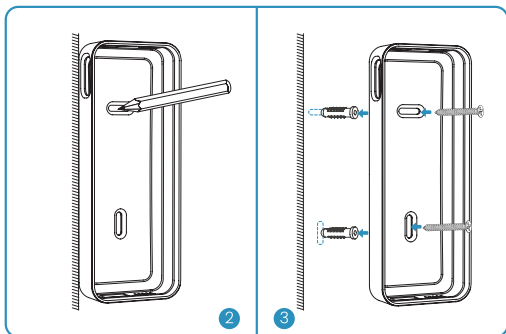

4. Las cintas adhesivas son opcionales para montar el timbre en superficies planas.
5. Fija el timbre a su soporte trasero y presiónalo para bloquearlo.

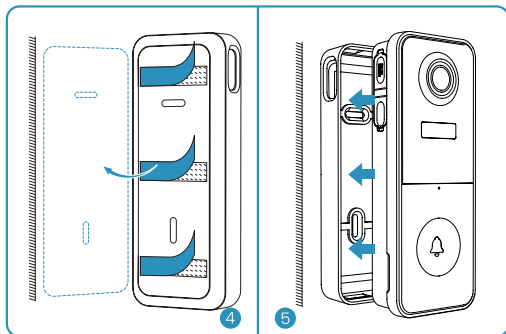

6. ¡Listo! Presiona el botón del timbre para ejecutar una prueba.

Escanea el código QR para obtener un video detallado de conexión e instalación del timbre ieGeek.

Si tienes alguna pregunta, contáctanos por correo electrónico: service@iegeek.com.



09/Solución de problemas

P1: ¿El timbre con video funciona con batería?

R1: Sí, tiene una batería de iones de litio incorporada. Gracias a la tecnología de bajo consumo de energía, una carga completa dura aproximadamente 2 meses en nuestro entorno de prueba de laboratorio (Condición de prueba de laboratorio: 10 eventos por día, 15 segundos de grabación de video por evento). Cuando la temperatura es demasiado baja, la tasa de consumo de energía aumentará.

P2: ¿Admite fuente de alimentación con cableado tradicional?

R2: No, no es compatible.

P3: ¿El timbre admite WiFi de 5 GHz?

R3: No, solo admite WiFi de 2,4 GHz.

P4: ¿Cuántos timbres inalámbricos se pueden agregar al timbre?

R4: Puede agregar varios timbres inalámbricos para que funcionen con su timbre con video.

P5: ¿Admite zonas de detección de movimiento personalizadas?

R5: Sí, lo hace. Puede personalizar la zona de detección en la configuración del timbre.

P6: ¿El timbre admite almacenamiento en la nube?

R6: Su timbre admite almacenamiento de video local mediante tarjeta Micro SD. También puede activar el servicio de almacenamiento en la nube gratuito en la aplicación. El almacenamiento en la nube gratuito admite grabación de video de 6 segundos y el tiempo de almacenamiento es de siete días.

Establecer ruta: Configuración---Servicio de almacenamiento en la nube---Almacenamiento en la nube básico---Desplácese hasta la parte inferior de la página---Pulse para activar

P7: ¿Cómo instalar la tarjeta Micro SD?

R7: Use el pasador incluido para insertarlo en el pequeño orificio en la parte inferior del timbre para quitar el timbre del soporte. La ranura para tarjeta SD está en el lado izquierdo.
(El timbre y el soporte están integrados cuando lo recibe)

ITALIANO

01	Cosa c'è nella scatola?	53
02	Ecco il campanello video	54
03	Scopri il campanello interno	55
04	Cargar el campanello video	56
05	Download dell'app	57
06	Imposta il campanello	57
07	Associa al tuo campanello interno	60
08	Installa il campanello	61
09	Risoluzione dei problemi	63

01/Cosa c'è nella scatola?

Consultare la checklist sottostante per tutti i componenti.

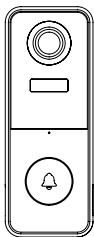

Campanello Video (con staffa)



Campanello Interno

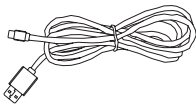

Cavo di ricarica

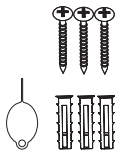

Viti e utensili

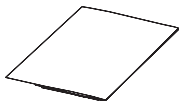

Guida utente

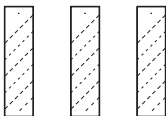

Nastro biadesivo

02/Ecco il campanello video

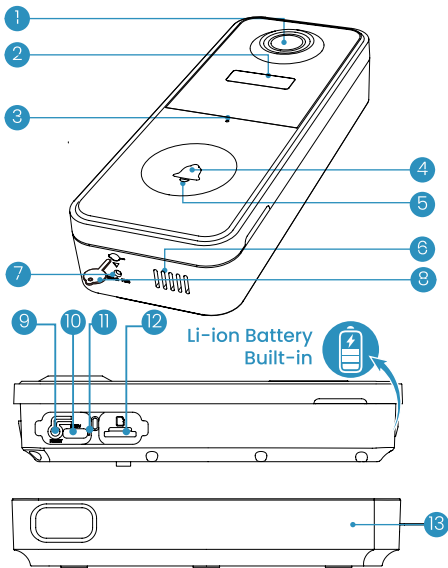

1	Lente	2	Sensore di Movimento PIR
3	Microfono	4	Pulsante del Campanello (pulsante di accensione)

5	Indicatore LED	6	Altoparlante
7	Foro di Sblocco	8	Perno di Sblocco
9	Pulsante di Reset	10	Porta di Ricarica
11	Indicatore di Ricarica	12	Slot per Scheda Micro-SD
13	Supporto per Campanello		

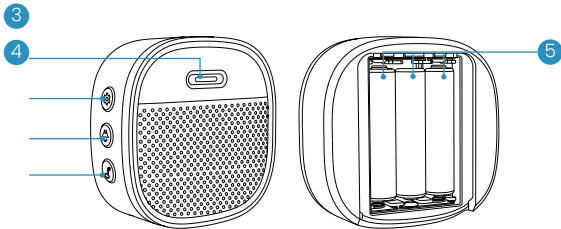

*Quando ricevi il prodotto, il campanello e la staffa sono integrati.

03/Scopri il campanello interno



1	Indicatore LED	2	Impostazione
3	Controllo del volume	4	Seleziona suoneria
5	Batterie AAA		

04/Cargar el campanello video

STATO LED	INDICAZIONE
 Rosso fisso	Batteria in carica
 Blu fisso	Completamente carica

Caricabatterie compatibile (non incluso): Caricabatterie per cellulare compatibile con USB (DC 5V 1A~2A)

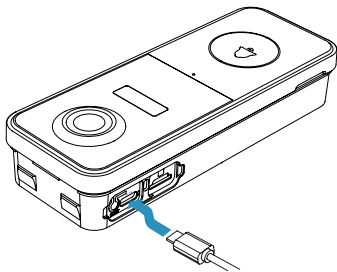

Durata della batteria: 1-2 mesi

In ambienti di laboratorio, il campanello wireless funziona per 2 mesi con 20 attivazioni al giorno.

Suggerimenti: la durata della batteria dipende dalla temperatura, dalla frequenza di attivazione PIR e dai fattori di invecchiamento della batteria.

05/Download dell'app

Cerca "ieGeek Cam" nell'APP Store o scansiona i codici QR qui sotto per scaricare l'APP. (Supporta anche l'APP "CloudEdge")



ieGeek Cam



ieGeek Cam

Seleziona la tua regione e usa il tuo indirizzo email per registrarti o accedere all'APP.

06/Imposta il campanello

6.1. Installa la scheda Micro SD (non inclusa)

1. Utilizza lo strumento di sblocco incluso per inserirla nel piccolo foro sul fondo.
2. Rimuovi il campanello dalla staffa.
3. Inserisci la scheda Micro SD nello slot per schede sul lato sinistro del campanello.

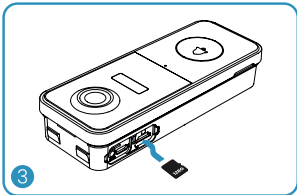
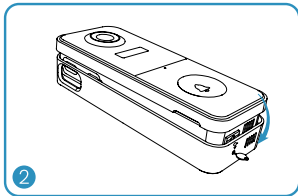
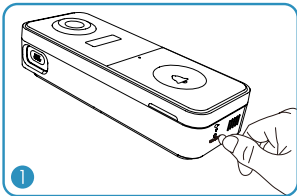

Note per la scheda Micro SD

1. Inserisci la scheda Micro SD prima di accendere, altrimenti la scheda Micro SD non può essere rilevata.
2. Il campanello ieGeek supporta schede Micro SD fino a 128 GB.
3. Condizione richiesta: velocità di lettura e scrittura di classe 10 e formato file FAT32 (formattato prima dell'uso).

6.2 Collega il campanello al Wi-Fi

Premi il pulsante del campanello per attivarlo e vedrai l'indicatore LED lampeggiare in rosso (una volta al secondo). In caso contrario, tieni premuto il pulsante di ripristino per 5 secondi per ripristinare le impostazioni di fabbrica.

Metodo 1: Configurazione Bluetooth

1. Sulla home page, tocca "Aggiungi" o "+" nell'angolo in alto a destra, tocca "Aggiungi dispositivo".
2. Se il Bluetooth del cellulare non si accende, l'app mostrerà un pop-up, consentigli di accendere il Bluetooth.

3. Dopo che il Bluetooth si accende, l'app cercherà automaticamente i dispositivi accesi e non associati. Seleziona il dispositivo che vuoi connettere nell'elenco di ricerca.

Metodo 2: Scansiona il codice QR

1. Sulla home page, tocca "Aggiungi" o "+" nell'angolo in alto a destra, tocca "Aggiungi dispositivo".

2. Scegli Smart Doorbell (WiFi 2.4G) e segui le istruzioni nell'app.

Suggerimenti:

- Utilizza le impostazioni vicino al router Wi-Fi.
- Assicurati che il telefono sia connesso al Wi-Fi 2.4GHz.
- Assicurati che il campanello sia acceso e che l'indicatore LED lampeggi in rosso. In caso contrario, tieni premuto RESET per 5 secondi.
- Assicurati che il segnale Wi-Fi sia buono e che la password Wi-Fi sia corretta..

STATO LED	INDICAZIONE
 Rosso fisso	Il dispositivo è anomalo.
 Rosso lampeggiante (una volta al secondo)	Pronto per la configurazione Wi-Fi.
 Rosso lampeggiante (due volte al secondo)	Connessione al Wi-Fi
 Blu fisso	Il dispositivo è online
 Blu lampeggiante (una volta al secondo)	Videocamera con campanello con visualizzazione in tempo reale
 Blu lampeggiante (due volte al secondo)	Aggiornamento firmware

07 / Associa al tuo campanello interno

Quando ricevi il prodotto, il campanello e il campanello sono collegati per impostazione predefinita. Se scopri che il campanello non è collegato al campanello, puoi collegarlo manualmente come segue:

1. Fai clic sul pulsante IMPOSTAZIONE sul campanello e il campanello sarà in modalità di associazione per 20 secondi, con il suo LED rosso lampeggiante.

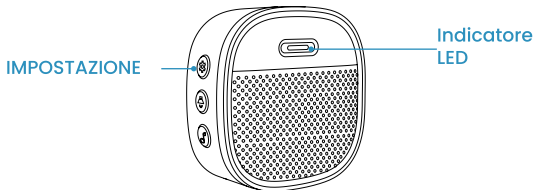

2. Premi il pulsante del campanello per inviare un segnale di associazione e il tuo campanello suonerà per reagire, insieme al suo LED blu lampeggiante. L'associazione del campanello riesce.

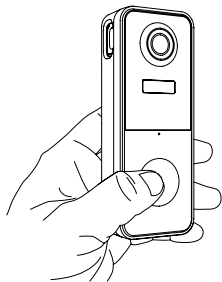

Il campanello suona e l'indicatore lampeggia in blu

08/Installa il campanello

- Seleziona la posizione per il tuo campanello.

Seleziona una posizione.

Si consiglia di montare il campanello ad almeno 4 piedi (120 cm) dal suolo per un angolo di visione ottimale e le migliori prestazioni di rilevamento del movimento.

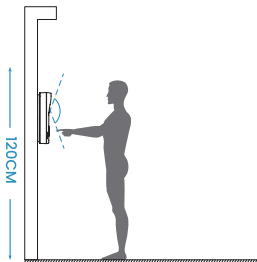

Monta il tuo campanello.

1. Sblocca il supporto posteriore utilizzando il perno di sblocco.

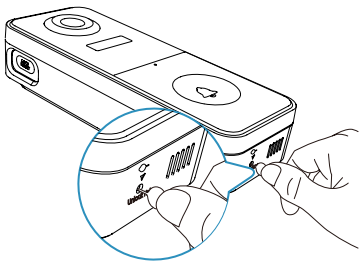

2. Segna i fori per le viti con il supporto del campanello.
3. Monta il supporto posteriore alla parete con viti e utensili.

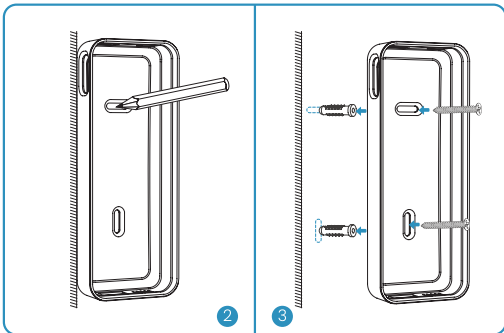

4. I nastri adesivi sono facoltativi per montare il campanello su superfici piane.
5. Fissa il campanello al suo supporto posteriore e spingi il campanello per bloccarlo.

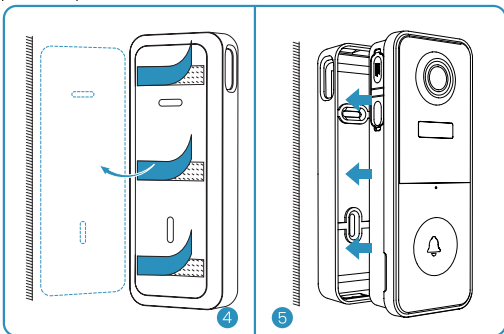

6. Tutto pronto! Premi il pulsante del campanello per eseguire un test.

Scansiona il codice QR per ottenere un video dettagliato sulla connessione e l'installazione di ieGeek Doorbell.

In caso di domande, contattaci tramite e-mail: service@iegeek.com.



09/Risoluzione dei problemi

D1: Il videocitofono è alimentato a batteria?

R1: Sì, è dotato di una batteria agli ioni di litio integrata. Grazie alla tecnologia a basso consumo energetico, una carica completa dura circa 2 mesi nel nostro ambiente di test di laboratorio (condizioni di test di laboratorio: 10 eventi al giorno, 15 secondi di registrazione video per evento). Quando la temperatura è troppo bassa, il consumo energetico aumenta.

D2: Supporta l'alimentazione cablata legacy?

R2: No, non lo supporta.

D3: Il campanello supporta il WiFi a 5 GHz?

R3: No, supporta solo il WiFi a 2,4 GHz.

D4: Quanti campanelli wireless possono essere aggiunti al campanello?

R4: Puoi aggiungere diversi campanelli wireless per funzionare con il tuo videocitofono.

D5: Supporta zone di rilevamento del movimento personalizzate.

R5: Sì, lo fa. Puoi personalizzare la zona di rilevamento nelle impostazioni del campanello.

D6: Il campanello supporta l'archiviazione su cloud?

R6: Il campanello supporta l'archiviazione video locale tramite scheda Micro SD. Puoi anche attivare il servizio di archiviazione su cloud gratuito nell'app. L'archiviazione su cloud gratuita supporta la registrazione video di 6 secondi e il tempo di archiviazione è di sette giorni.

Imposta percorso: Impostazioni---Servizio di archiviazione su cloud---Archiviazione su cloud di base---Scorri fino in fondo alla pagina---Tocca per attivare



This device complies with Part 15 of the FCC Rules. Operation is subject to the following two conditions:

- (1) This device may not cause harmful interference, and
- (2) this device must accept any interference received, including interference that may cause undesired operation.



Tiger-Zhou UG (haftungsbeschränkt)
Leipzig HRB 37898 Shukowstr. 6 04347
Leipzig, Sachsen, Deutschland
Tiger-Zhou@web.de
+4915216791470



Sea5Mew Accounting Ltd
Electric Avenue Vision 25, London,
Enfield EN3 7GD
info@seamew.net
+447399548608

Made in China
IC: 25978-BELLJ9
FCC ID:2AUSP-BELLJ6





ieGeek



www.iegeek.com

ieGeek and ieGeek logo are trademarks of Shenzhen Globalebuy Co., Ltd, registered in the United States and other countries. All right reserved.